

Life
made
easy

Mechanical
excellence



NUOVI CARDINI COMUNELLO

Ancora più facili da regolare!

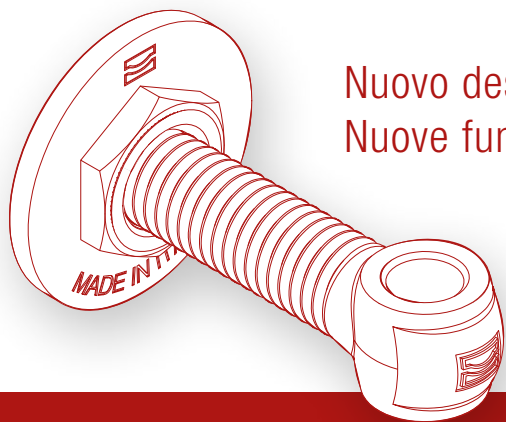

Nuovo design
Nuove funzionalità



COMUNELLO
GATE DIVISION

01 Nuovo design e più ampio range di regolazione:

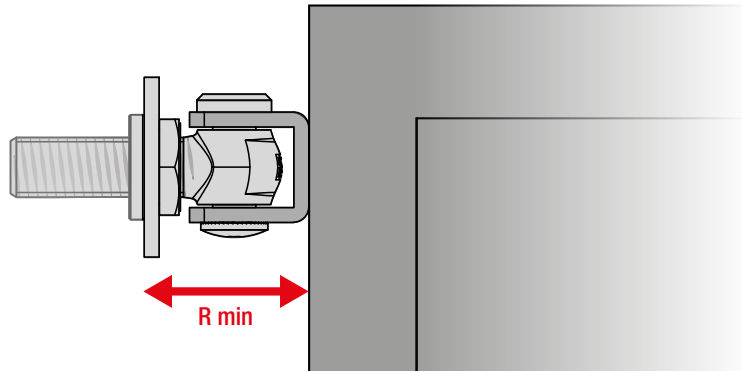

Grazie al nuovo anello a saldare è possibile ridurre la distanza tra anta e pilastro (R min).

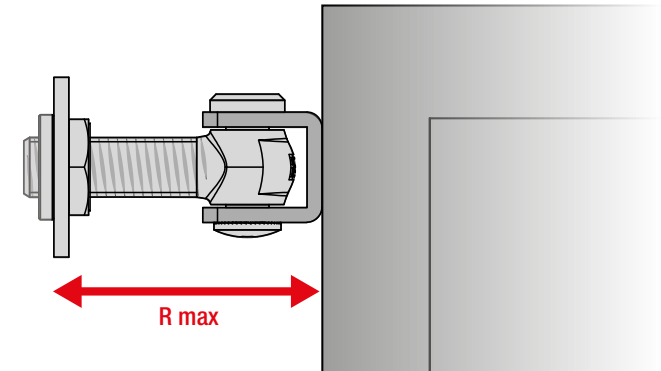

La maggiore lunghezza del perno permette di aumentare la distanza tra anta e pilastro (R max). Sviluppo disponibile entro fine 2017.

02 Regolazione piu' agevole:

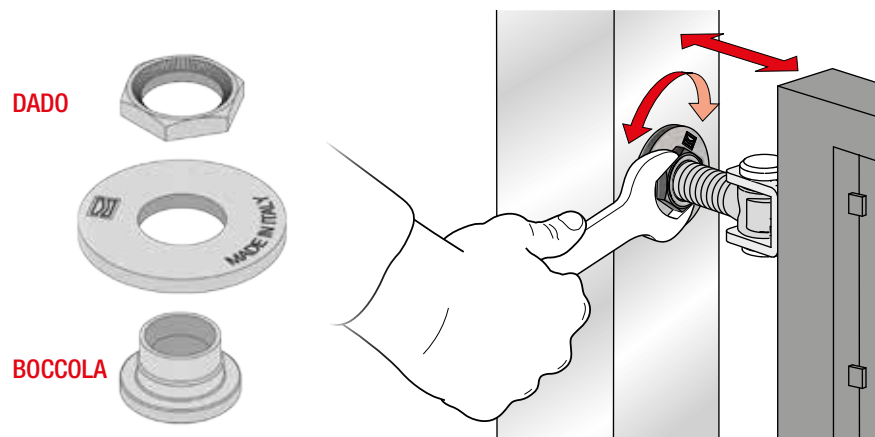

Il nuovo sistema di imbroccatura del dado sulla boccola, permette di regolare il cardine con estrema facilità **a cancello installato**.

03 Ottimale presa sulla piastra:

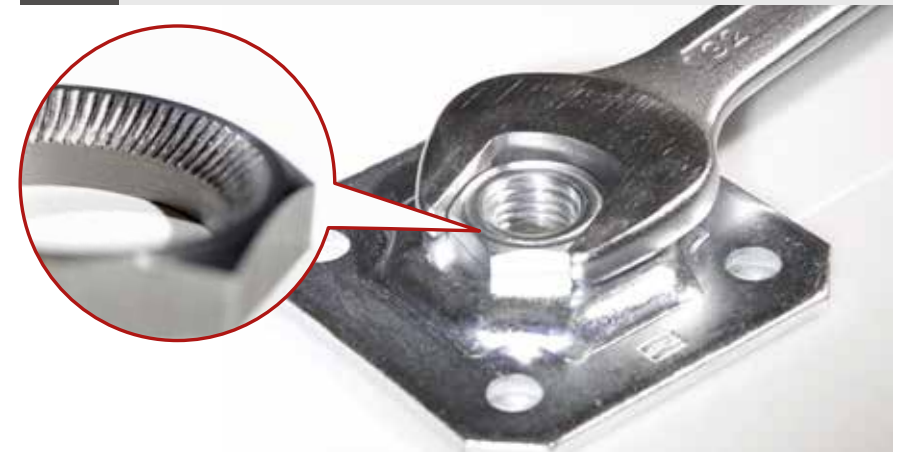

La **zigrinatura** opportunamente creata sul dado, assicura una presa ottimale tra boccola e dado, sia nei cardini a saldare che nei cardini a fissare

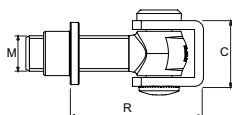

120

- Cardine con cavallotto e bussola

		C	M	R	⚖️	🗨️	🔧	€
NEW	120-M16	zinc	37	M16	50-80	95 Kg*	20	8,5
	120-M18	zinc	37	M18	50-80	125 Kg*	20	9 5,438
	120-M20	zinc	37	M20	50-80	150 Kg*	20	9 5,727
	120-M22	zinc	49	M22	55-80	220 Kg*	10	7,2 7,725
	120-M24	zinc	49	M24	55-85	225 Kg*	10	7,7 8,580
	120-M20 Hs700	Hs700	37	M20	50-80	150 Kg*	20	9 14,307
	120-M24 Hs700	Hs700	49	M24	55-85	225 Kg*	10	7,7 20,023

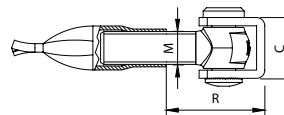

125

- Cardine con cavallotto a cementare

		C	M	R	⚖️	🗨️	🔧	€
NEW	125-M18	zinc	37	M18	45-85	125 Kg*	20	9,9
	125-M20	zinc	37	M20	45-85	150 Kg*	20	10,5 8,302
NEW	125-M22	zinc	49	M22	70-90	220 Kg*	10	7,6
	125-M24	zinc	49	M24	70-90	225 Kg*	10	8,1 13,730

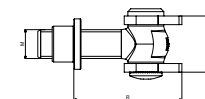

135

- Cardine con ali e bussola

		C	M	R	⚖️	🗨️	🔧	€
NEW	135-M16	zinc	39	M16	50-80	95 Kg*	20	7,9
	135-M18	zinc	39	M18	50-80	125 Kg*	20	8,4 6,005
	135-M20	zinc	39	M20	50-80	150 Kg*	20	9,2 6,293
	135-M22	zinc	53	M22	55-80	220 Kg*	10	7,3 8,704
	135-M24	zinc	53	M24	60-85	225 Kg*	10	8,3 12,123
	135-M27	zinc	60	M27	62-105	320 Kg*	10	11,5 16,470

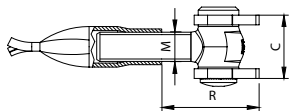

140

- Cardine con ali a cementare

		C	M	R	⚖️	🗨️	🔧	€
	140-M18	zinc	39	M18	45-85	125 Kg*	20	7,5 7,746
NEW	140-M20	zinc	39	M20	45-85	150 Kg*	20	8,1
	140-M22	zinc	53	M22	70-90	220 Kg*	10	5,8 10,897
NEW	140-M24	zinc	53	M24	70-90	225 Kg*	10	6,4
	140-M27	zinc	60	M27	85-105	320 Kg*	10	11 17,386

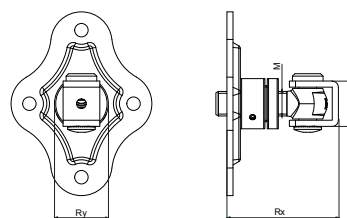
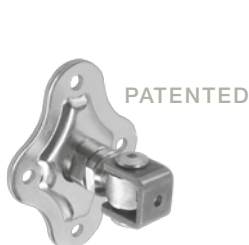

154R-CV

- Piastra "Rustica" doppia regolazione su 2 assi x - y

		C	M	Rx	Ry	⚖️	🗨️	🔧	€
	154R-CV-M18	zinc	37	18	82-96	10	125 kg*	20	18 31,168
	154R-CV-M20	zinc	37	20	87-96	10	150 kg*	20	18,3 31,477
	154R-CV-M22	zinc	49	22	94-103	10	220 kg*	10	13,2 31,580
	154R-CV-M24	zinc	49	24	95-108	10	225 kg*	10	13,5 31,848

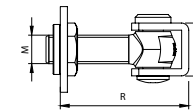

155

- Cardine con cavallotto e dado regolabile

		C	M	R	⚖️	🗨️	🔧	€
NEW	155-M16	zinc	37	M16	55-90	95 Kg*	20	10
	155-M18	zinc	37	M18	55-90	125 Kg*	20	10,5 7,148
	155-M20	zinc	37	M20	55-90	150 Kg*	20	11 8,580
NEW	155-M22	zinc	49	M22	65-95	220 Kg*	10	8,3
	155-M24	zinc	49	M24	65-100	225 Kg*	10	8,8 12,875

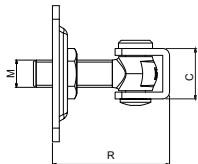
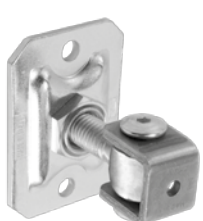

157CV

- Piastra "Rettangolare" con dado regolabile

		C	M	R	⚖️	🗨️	🔧	€
	157CV-M18	zinc	37	18	65-95	125 Kg*	20	13,5 9,950
	157CV-M20	zinc	37	20	65-95	150 Kg*	20	13,6 13,730
	157CV-M22	zinc	49	22	70-100	220 Kg*	10	9,5 19,745
	157CV-M24	zinc	49	24	70-105	225 Kg*	10	10 22,320

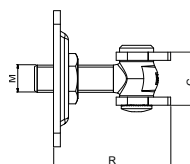

157AL

- Cardine con ali e piastra "rettangolare" con dado regolabile

		C	M	R	⚖️	🗨️	🔧	€
	157AL-M18	zinc	39	M18	65-95	125 kg*	20	13 12,731
	157AL-M20	zinc	39	M20	65-95	150 kg*	20	13,6 14,018
	157AL-M22	zinc	53	M22	70-100	220 kg*	10	9,7 20,023
	157AL-M24	zinc	53	M24	70-105	225 kg*	10	10,6 22,598

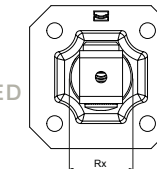
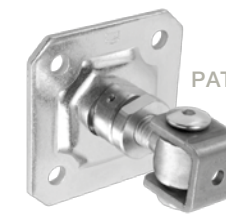

159R-CV

- Piastra "Quadrata" doppia regolazione su 2 assi x - y

		C	M	Rx	Ry	⚖️	🗨️	🔧	€
	159R-CV-M18	zinc	37	18	82-96	10	125 kg*	20	17,5 28,335
	159R-CV-M20	zinc	37	20	87-96	10	150 kg*	20	17,7 28,613
	159R-CV-M22	zinc	49	22	94-103	10	220 kg*	10	13 28,706
	159R-CV-M24	zinc	49	24	95-108	10	225 kg*	10	13,3 28,953

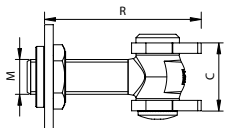

160

- Cardine con ali e dado regolabile

	C	M	R	A	U	€
NEW 160-M16	zinc 39	M16	55-90	95 Kg*	20 10,2	
160-M18	zinc 39	M18	55-90	125 Kg*	20 10,5	8,384
NEW 160-M20	zinc 39	M20	55-90	150 Kg*	20 11	
160-M22	zinc 53	M22	65-95	220 Kg*	10 8,9	10,990
NEW 160-M24	zinc 53	M24	65-100	225 Kg*	10 9,4	
160-M27	zinc 60	M27	75-120	320 Kg*	10 11,5	17,768

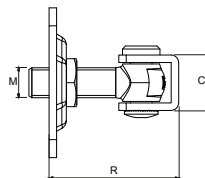

161

- Cardine con cavalletto e piastra con dado regolabile

	C	M	R	A	U	€
NEW 161-M16	zinc 37	M16	65-95	95 Kg*	20 14,5	
161-M18	zinc 37	M18	65-95	125 Kg*	20 15	13,874
161-M20	zinc 37	M20	65-95	150 Kg*	20 16,2	16,027
NEW 161-M22	zinc 49	M22	70-100	220 Kg*	10 9,3	
161-M24	zinc 49	M24	70-105	225 Kg*	10 11	22,320

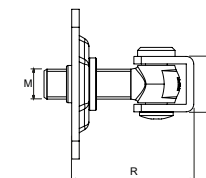

162

- Cardine con cavalletto e piastra con bussola

	C	M	R	A	U	€
162-M20	zinc 37	M20	60-90	150 Kg*	20 16	16,027
162-M24	zinc 49	M24	65-100	225 Kg*	10 11,2	22,320

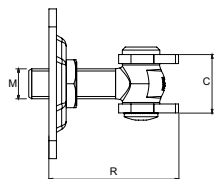

163

- Cardine con ali e piastra con dado regolabile

	C	M	R	A	U	€
NEW 163-M16	zinc 39	M16	65-95	95 Kg*	20 14	
163-M18	zinc 39	M18	65-95	125 Kg*	20 14,6	13,730
NEW 163-M20	zinc 39	M20	65-95	150 Kg*	20 15,4	
163-M22	zinc 53	M22	70-100	220 Kg*	10 11	17,170
163-M24	zinc 53	M24	70-105	225 Kg*	10 11,5	21,455
163-M27	zinc 60	M27	80-125	320 Kg*	10 18,3	28,263

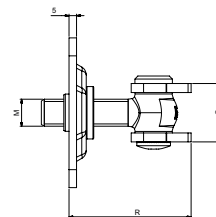

164

- Cardine con ali e piastra con bussola

	C	M	R	A	U	€
164-M18	zinc 39	M18	62-90	125 Kg*	20 14	13,730
164-M22	zinc 53	M22	70-95	220 Kg*	10 8,8	17,170
164-M27	zinc 60	M27	75-117	320 Kg*	10 16,9	27,182



159

- Piastra "Quadrata" con dado regolabile

	C	M	R	A	U	€
NEW 159-M16	zinc 10	4,5				
159-M18	zinc 10	4,5				10,012
159-M20	zinc 10	4,5				10,877
159-M22	zinc 10	4,5				12,020
159-M24	zinc 10	4,5				12,875
159-M27	zinc 10	8				15,738

154

- Piastra "Rustica" con dado regolabile

	C	M	R	A	U	€
154-M18	zinc 10	4,8				10,012
154-M20	zinc 10	4,8				10,877
154-M22	zinc 10	4,8				12,020
154-M24	zinc 10	4,8				12,875
154-M27	zinc 10	5,5				15,738

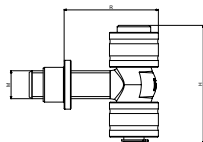

172

- Cardine cilindrico con bussola

	H	M	R	A	U	€
172-M18	zinc 85	M18	43-72	125 Kg*	20 9,2	18,427
172-M20	zinc 85	M20	43-72	155 Kg*	20 11,5	19,086
172-M24	zinc 103	M24	46-79	240 Kg*	10 10,3	21,383

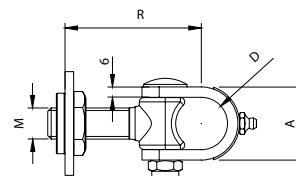

182

- Cardine a fascetta con ingrassatore e dado regolabile

	D	M	R	A	U	€
182-M18	zinc Ø30	M18	55-80	100 Kg*	20 9,7	14,307
182-M22	zinc Ø35	M22	64-90	160 Kg*	10 7,1	18,602
182-M27	zinc Ø40	M27	75-105	260 Kg*	10 11,7	28,737

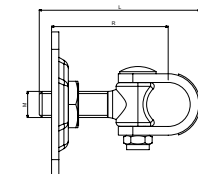

186

- Cardine a fascetta con ingrassatore e piastra con dado regolabile

	L	M	R	A	U	€
186-M18	zinc 111	M18	60-85	100 Kg*	20 16,6	21,455
186-M22	zinc 126	M22	65-95	160 Kg*	10 10,3	25,173
186-M27	zinc 145	M27	80-110	260 Kg*	10 16,7	37,193